

The product using material and processing must conform to the "WI-PZ-001" HSF technical standard control requirements

RoHS

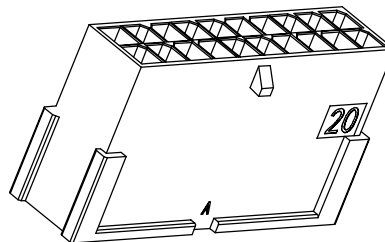
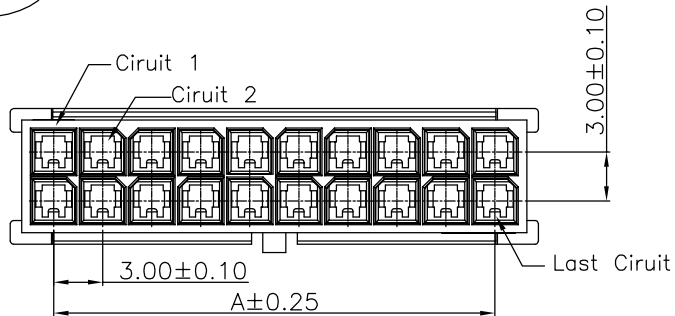

NOTE:

- 1.MATERIAL SPECIFICATION:
  - 1-1.HOUSING: PA66,
- 2.ELECTRICAL PERFORMANCE:
  - 2-1.INSULATION RESISTANCE: 1000MΩ Min
  - 2-2.WITHSTANDING VOLTAGE : 1000V AC
- 3.ENVIRONMENTAL PERFORMANCE:
  - 3-1.OPERATING TEMPERATURE: -25°C~+85°C.
- 4.PACKAGE SPEC: PE BAG
- 5.P/N:

SERIES NO: C3030 H F-2 XX X X  
 CONNECTOR: H HOUSING  
 MALE FEMALE: F-FEMALE  
 ROW NO: 2-DOUBLE ROW  
 HOUSING:  
 1-UL94V-0  
 2-UL94V-2  
 COLOR:  
 A-BLACK  
 S-NATURE  
 PIN Q'PY:  
 02~24

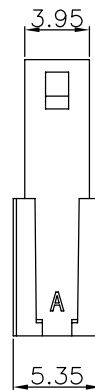
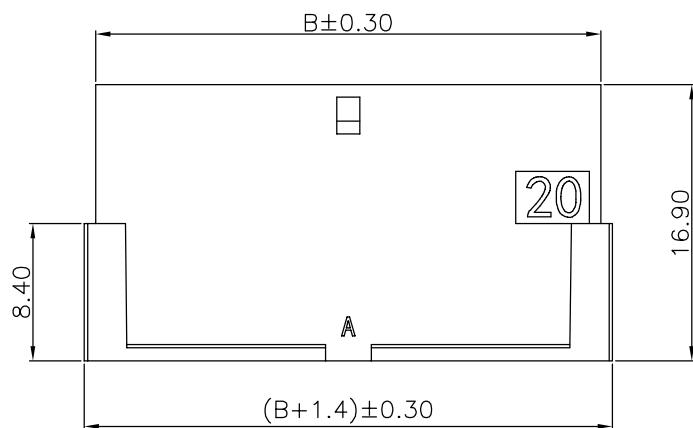

2\*1P

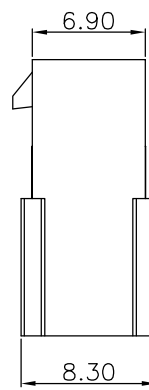

Circuit	Dimensions (mm)		Circuit	Dimensions (mm)	
	A	B		A	B
2*01	---	3.95	2*07	18.00	21.95
2*02	3.00	6.95	2*08	21.00	24.95
2*03	6.00	9.95	2*09	24.00	27.95
2*04	9.00	12.95	2*10	27.00	30.95
2*05	12.00	15.95	2*11	30.00	33.95
2*06	15.00	18.95	2*12	33.00	36.95

REV.	REVISION RECORD	DATE	UNIT:mm	GENERAL TOLERANCES		SCALE:	NAME	DATE	PART.NO:	DWG.NO:	 WanLian Technology Co., Ltd
A0	NEW RELEASE	21.11.17		LINEAR	ANGLES	1:1					
			0.00±0.25	X'±3'	APPROVED	Wang_jr	21.11.17	C3030HF-2XXXX	ENDE05		
			0.00±0.10	X'X' ±2'	DESIGNER	Han_Gao	21.11.17	TITLE:			
			SIZE: A4		DRAWN	Zijun_Huang	21.11.17	Pitch3.00mm 180° 双排带扣不带翅螺母胶壳无LOGO		REV: A0 SHEET: 1/3	

The product using material and processing must conform to the "WI-PZ-001"HSF technical standard control requirements

RoHS

### 孔位图

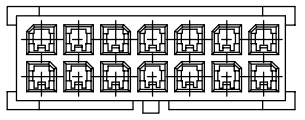

2X7PIN

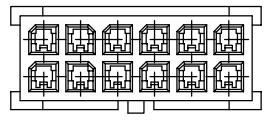

2X6PIN

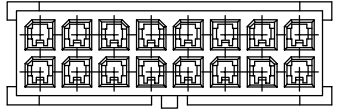

2X8PIN

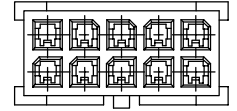

2X5PIN

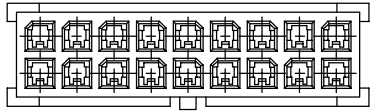

2X9PIN

2X4PIN



2X10PIN

2X3PIN

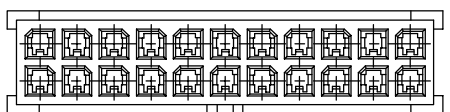

2X11PIN

2X2PIN

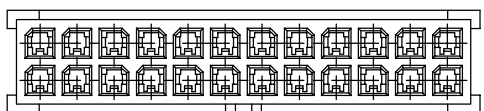

2X12PIN

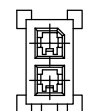

2X1PIN

REV.	REVISION RECORD	DATE		GENERAL TOLERANCES		SCALE: 1:1	NAME	DATE	PART.NO:	DWG.NO:	 WanLian Technology Co., Ltd
A0	NEW RELEASE	21.11.17		LINEAR	ANGLES	APPROVED	Wang_jr	21.11.17	C3030HF-2XXXX	ENDE05	
			UNIT:mm	0.00±0.25	X'±3'	DESIGNER	Han_Gao	21.11.17	TITLE:		REV: A0      SHEET: 2/3
			SIZE: A4	0.000±0.10	X'X' ±2'	DRAWN	Zijun_Huang	21.11.17	Pitch3.00mm 180° 双排带扣不带翅膀母胶壳无LOGO		

The product using material and processing must conform to the "WI-PZ-001" HSF technical standard control requirements

RoHS

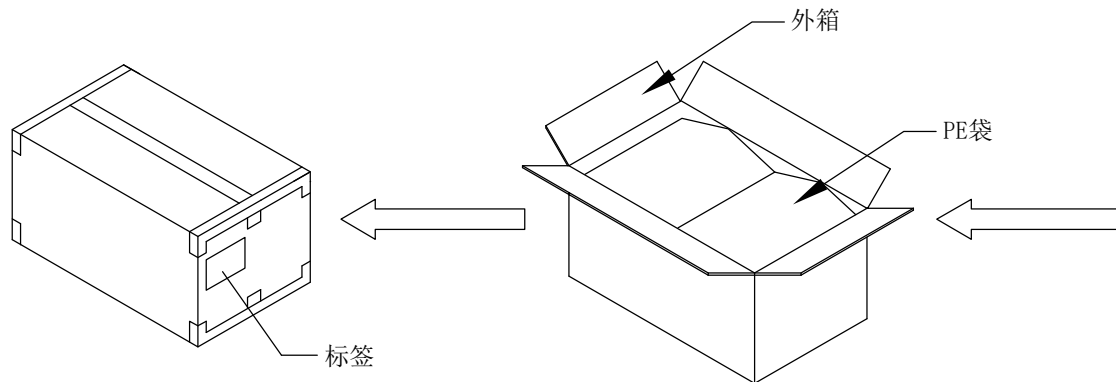
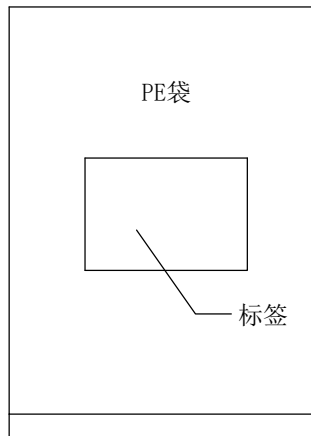
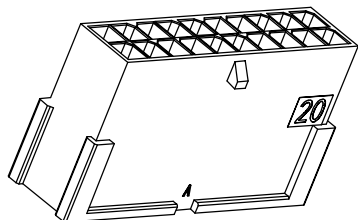

纸箱规格:465\*315\*426MM

注意事项:

1. 产品不可少数、多数;
2. 内外包装均需有数量标签;
3. 不同PIN位包装时须分开放置不可装入同一外箱中。
4. 同一订单尾数包装需用不影响品质之物品填充并注明尾数。

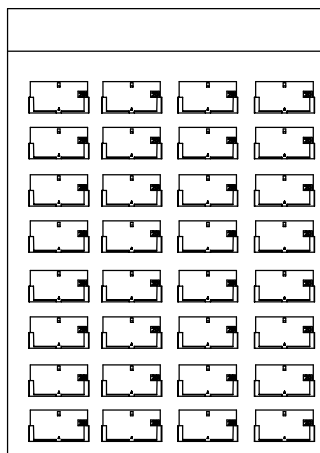

Circuit	Bag Pcs	CARTON Bag	CARTON Pcs
2*1	1K	30	30K
2*2	1K	30	30K
2*3	1K	25	25K
2*4	1K	25	25K
2*5	1K	20	20K
2*6	1K	20	20K
2*7	1K	20	20K
2*8	1K	10	10K
2*9	1K	10	10K
2*10	1K	8	8K
2*11	1K	8	8K
2*12	1K	8	8K

REV.	REVISION RECORD	DATE		GENERAL TOLERANCES		SCALE: 1:1	NAME	DATE	PART.NO: C3030HF-2XXXX	DWG.NO: ENDE05	 WanLian Technology Co., Ltd	
AO	NEW RELEASE	21.11.17		LINEAR	ANGLES	APPROVED	Wang_jr	21.11.17				
			UNIT:mm	0.00±0.25	X'±3'	DESIGNER	Han_Gao	21.11.17	TITLE: Pitch3.00mm 180° 双排带扣不带翅膀母胶壳无LOGO		REV: A0	SHEET: 3/3
			SIZE: A4	0.000±0.10	X'X' ±2'	DRAWN	Zijun_Huang	21.11.17				