

The product using material and processing must conform to the "WI-PZ-001" HSF technical standard control requirements

RoHS+HF

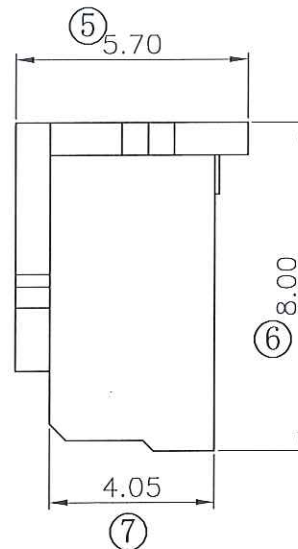
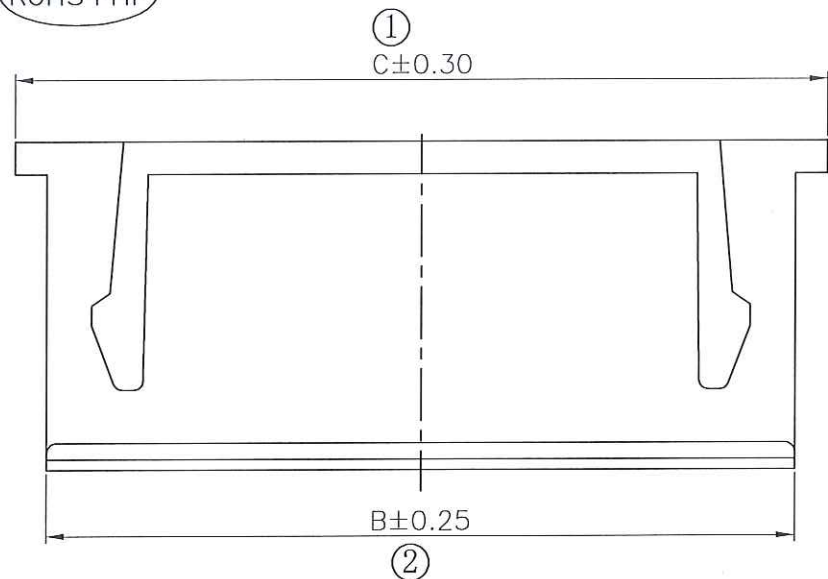

NOTE:

- 1.MATERIAL SPECIFICATION:  
1-1.HOUSING: PA66,UL94V-0
- 2.ELECTRICAL PERFORMANCE:  
2-1.INSULATION RESISTANCE: 1000MΩ Min  
2-2.DIELECTRIC WITHSTANDING : 1000V
- 3.ENVIRONMENTAL PERFORMANCE:  
3-1.OPERATING TEMPERATURE: -25°C~+85°C.
- 4.PACKAGE SPEC: PE BAG
- 5.P/N:

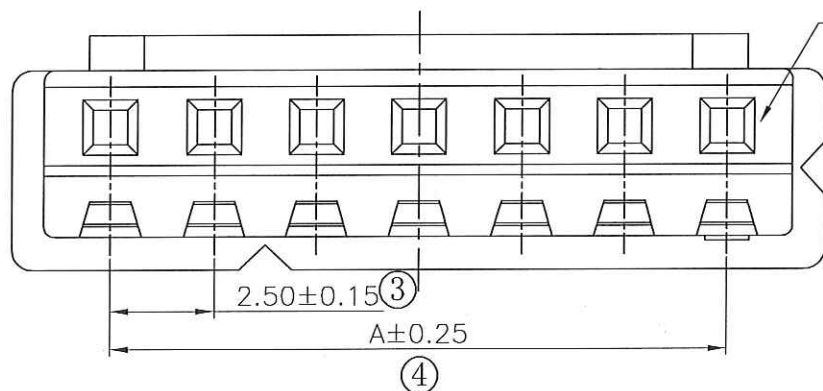
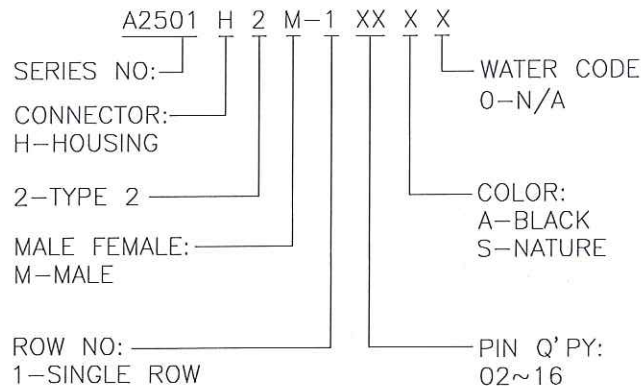

Circuit 1



Ordering Information & Dimensions

Circuit	Dimensions(mm)			Circuit	Dimensions(mm)		
	A	B	C		A	B	C
02	2.50	5.70	7.30	10	22.50	25.70	27.30
03	5.00	8.20	9.80	11	25.00	28.20	29.80
04	7.50	10.70	12.30	12	27.50	30.70	32.30
05	10.00	13.20	14.80	13	30.00	33.20	34.80
06	12.50	15.70	17.30	14	32.50	35.70	37.30
07	15.00	18.20	19.80	15	35.00	38.20	39.80
08	17.50	20.70	22.30	16	37.50	40.70	42.30
09	20.00	23.20	24.80				

REV.	REVISION RECORD	DATE	GENERAL TOLERANCES		SCALE:	NAME	DATE	PART.NO:	DWG.NO:
A0	NEW RELEASE	22.09.08	LINEAR	ANGLES	1:1			A2501H2M-1XXXX	ENDE05
			0.0±0.35	X'REF±6'	APPROVED	梁林权	2024.5.28		
			0.00±0.25	X'±3'	DESIGNER	梁林权	2024.5.28	TITLE:	
			0.000±0.10	X'X'±2'	DRAWN	肖西敏	2024.5.28	Pitch 2.50mm 180°XH MALE HOUSING	REV: A0 SHEET: 1/3



The product using material and processing must conform to the "WI-PZ-001"HSF technical standard control requirements

# PIN位示意图

RoHS+HF

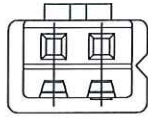

2P

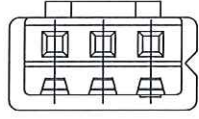

3P

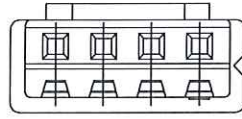

4P

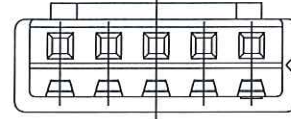

5P

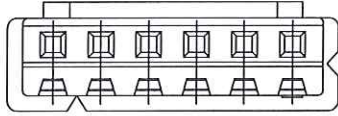

6P

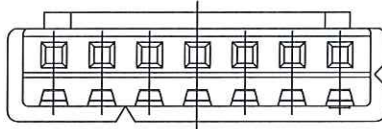

7P

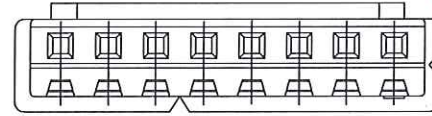

8P

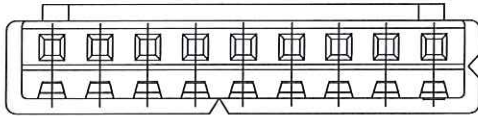

9P

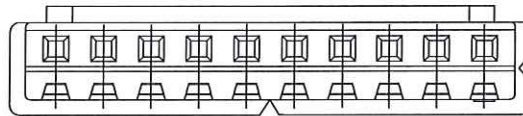

10P

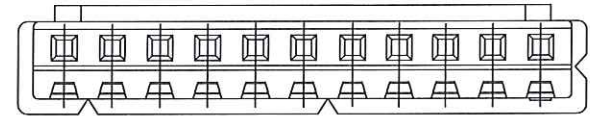

11P

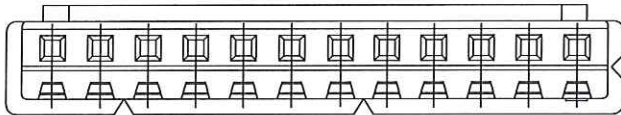

12P

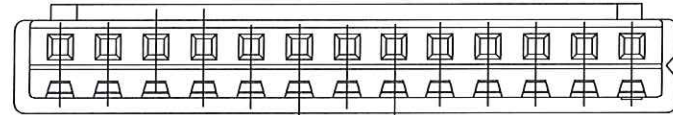

13P

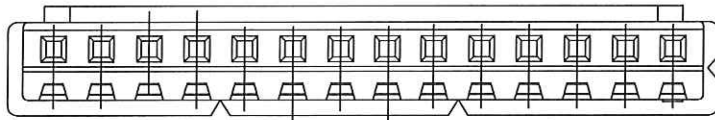

14P

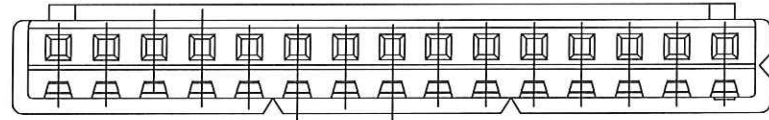

15P



REV.	REVISION RECORD	DATE	UNIT:mm	GENERAL TOLERANCES		SCALE: 1:1	NAME	DATE	PART.NO:	DWG.NO:	 WanLian Technology Co., Ltd
AO	NEW RELEASE			SIZE: A4	LINEAR 0.0±0.35	ANGLES X'REF±6'	APPROVED	8/8/24	2024.5.28	A2501H2M-1XXXX	
				0.00±0.25	X'±3'	DESIGNER	梁科和	2024.5.28	TITLE: Pitch 2.50mm 180°XH MALE HOUSING		REV: AO
				0.000±0.10	X'X' ±2'	DRAWN	肖和	2024.5.18			SHEET: 2/3

1

2

3

4

5

6

7

8



The product using material and processing must conform to the "WI-PZ-001"HSF technical standard control requirements



PE袋 1 Pcs

数量 :每袋=0.5~2Kpcs



NOTE(注):

1. 纸箱装箱以不超过装箱线为准,空余位置用塑料泡沫及保尼龙填充;
2. 纸箱分小、中、标准型3种规格型号; 装箱为整箱采用标准型纸箱包装,未达到整箱数量以产品量适当采用小型或中型纸箱包装;
3. 因生产Pin位未齐全,每袋与整箱包装数量仅供参考,具体包装数量以实际出货为准,或批量出货更新后为准;

纸箱型号 Carton Type	小型 Small Size	中型 Medium	标准型 Standard
高度 Hight (CM)	7.5	15	32

袋装包装数量	
CKT	PCS/BAG
2	2000
3	2000
4	2000
5	1000
6	1000
7	1000
8	1000
9	500
10	500
11	500
12	500
13	500
14	500
15	500
16	500

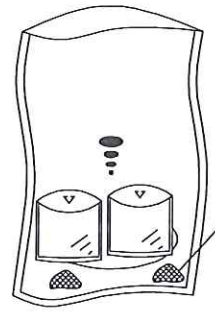
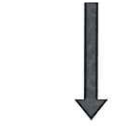

PE防水袋 1 Pcs

干燥剂

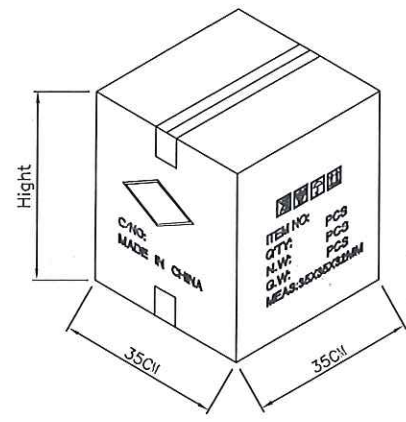
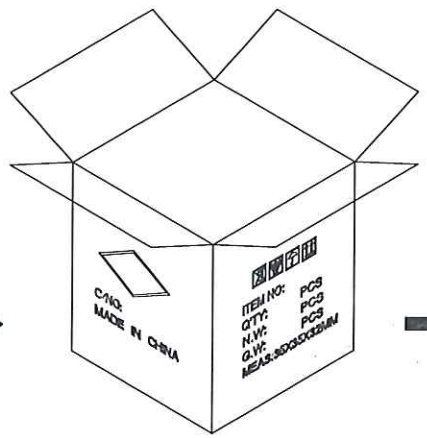

REV.	REVISION RECORD	DATE		GENERAL TOLERANCES		SCALE: 1:1	NAME	DATE	PART.NO: A2501H2M-1XXXX	DWG.NO: ENDE05	
A0	NEW RELEASE				LINEAR	ANGLES	APPROVED	8/2/24	2024.5.28		
				0.0±0.35	X'REF±6'	DESIGNER	梁林积	2024.5.28	TITLE: Pitch 2.50mm 180°XH MALE HOUSING		
				UNIT:mm	0.00±0.25	X'±3'	DRAWN	肖雨曦	2024.5.28		
				SIZE: A4	0.000±0.10	X'X' ±2'					