

The product using material and processing must conform to the "WI-PZ-001"HSF technical standard control requirements

RoHS+HF

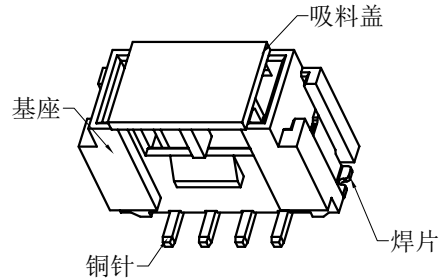

- NOTE:
- MATERIAL SPECIFICATION:
    - HOUSING: PA6T/LCP
    - CONTACTS: BRASS
    - SOLDERING LUG: BRASS
  - PLATING SPECIFICATION:
    - CONTACTS: SN PLATED OVER ALL.
    - SOLDERING LUG: SN PLATED OVER ALL.
  - ELECTRICAL PERFORMANCE:
    - CURRENT RATING: 2.0A
    - CONTACT RESISTANCE: 20mΩ Max.
    - INSULATION RESISTANCE: 1000MΩ MIN
    - DIELECTRIC WITHSTANDING: 1000V AC Min
  - ENVIRONMENTAL PERFORMANCE:
    - OPERATING TEMPERATURE: -25°C~+85°C.
  - PACKAGE SPEC: REEL
  - P/N ORDER:

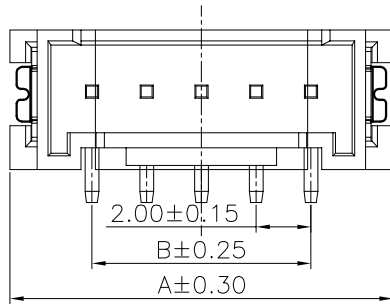
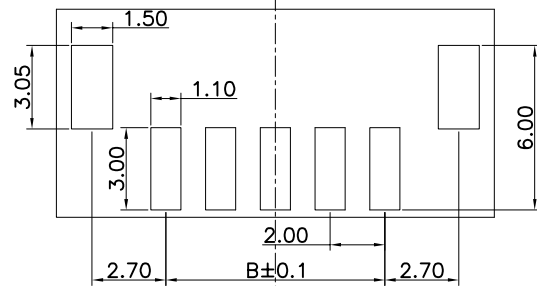
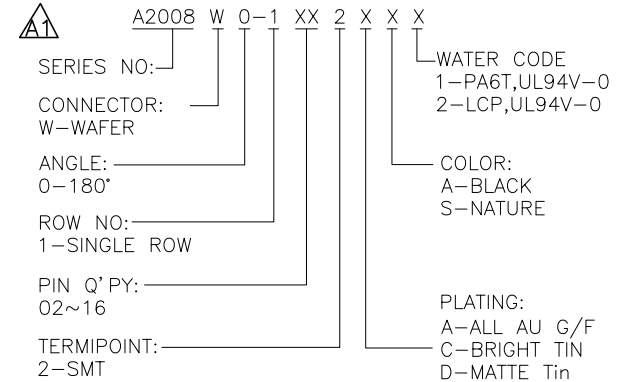
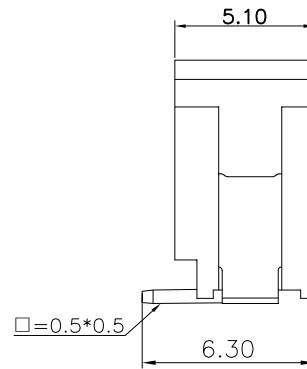
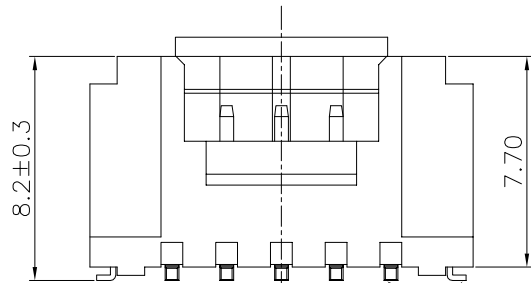

RECOMMENDED PCB LAYOUT  
(GENERAL TOLERANCE:±0.05)

Ordering Information & Dimensions

Circuits	Dimensions(mm)		Circuits	Dimensions(mm)	
	A	B		A	B
02	8.00	---	10	24.00	18.00
03	10.00	4.00	11	26.00	20.00
04	12.00	6.00	12	28.00	22.00
05	14.00	8.00	13	30.00	24.00
06	16.00	10.00	14	32.00	26.00
07	18.00	12.00	15	34.00	28.00
08	20.00	14.00	16	36.00	30.00
09	22.00	16.00			

REV.	REVISION RECORD	DATE	UNIT:mm	GENERAL TOLERANCES		SCALE:	NAME	DATE	PART.NO:	DWG.NO:	
A0	NEW RELEASE	21.01.13		LINEAR	ANGLES	1:1	Wang_jr	23.09.15	A2008W0-1XX2XXX	ENDE05	
A1	PART NUMBER RENEWAL	23.09.15	0.00±0.25	X'±3'	DESIGNER	Han_Gao	23.09.15	TITLE:	PITCH 2.0MM 180°HY SET UP POST WAFER		REV: A1
			SIZE: A4	0.000±0.10	X'X' ±2'	DRAWN	Zijun_Huang	23.09.15			SHEET: 1/2

The product using material and processing must conform to the "WI-PZ-001"HSF technical standard control requirements

RoHS+HF

备注:

- 1、10个孔的累积公差为±0.2mm
- 2、载长250mm内允许弯曲度1.0mm
- 3、材质: PS;100%回收再利用
- 4、所以尺寸符合EIA-481-D要求
- 5、上封带剥离强度: 20g~130g(0.2N~1.3N)
- 6、13英寸的卷盘每卷可装载600PCS

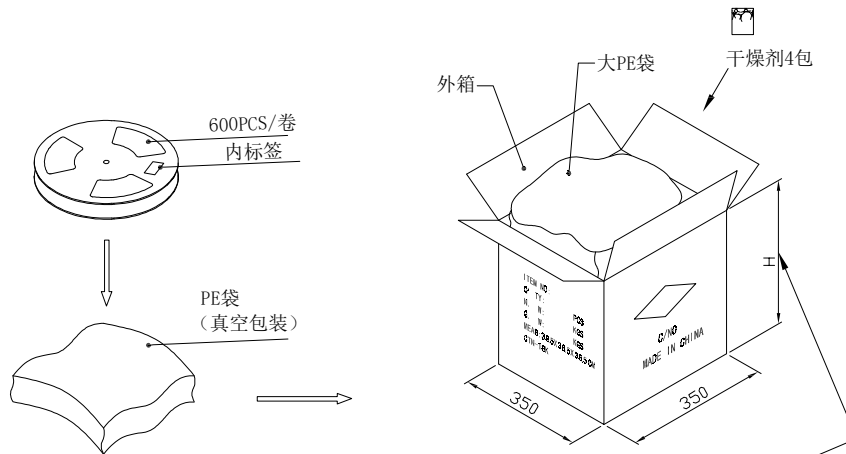
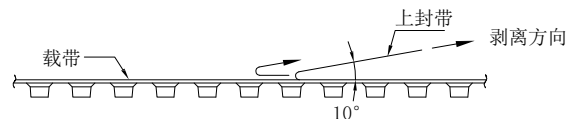
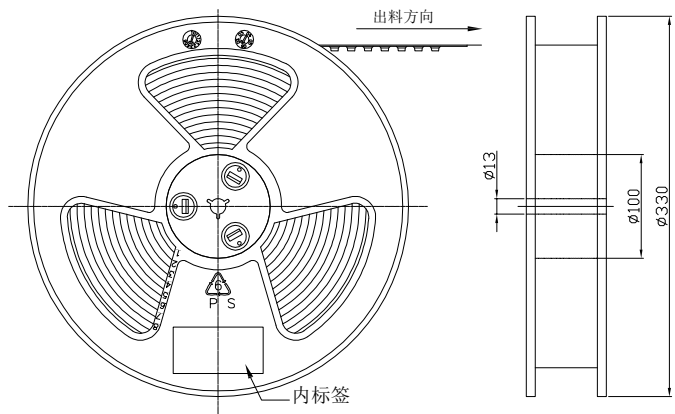
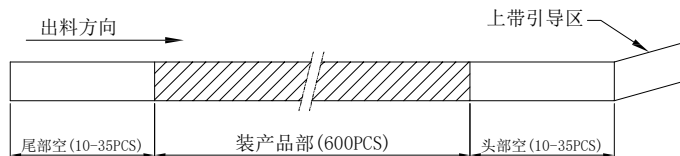
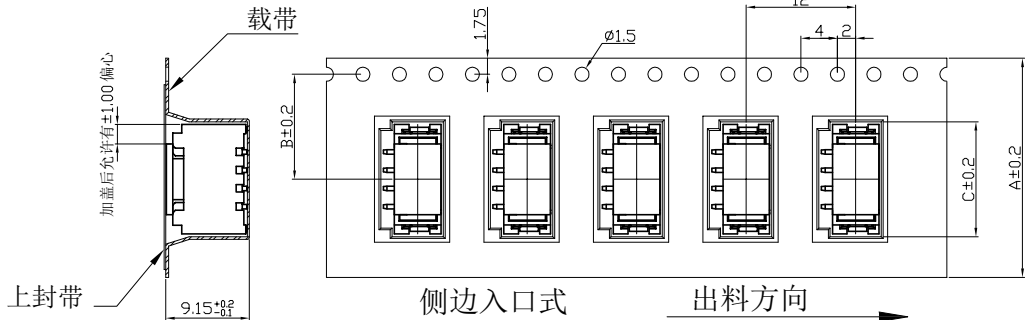

Circuits	DIM=A	DIM=B	DIM=C	1盘/只	1箱/盘	Circuits	DIM=A	DIM=B	DIM=C	1盘/只	1箱/盘
2P	24	11.5	8.2	600只	10盘	9P	44	20.2	22.3	600只	6盘
3P	24	11.5	10.2	600只	10盘	10P	44	20.2	24.3	600只	6盘
4P	24	11.5	12.2	600只	10盘	11P	44	20.2	26.3	600只	6盘
5P	24	11.5	14.2	600只	10盘	12P	44	20.2	28.3	600只	6盘
6P	24	11.5	16.2	600只	10盘	13P	44	20.2	30.3	600只	6盘
7P	32	14.2	18.3	600只	8盘	14P	44	20.2	32.3	600只	6盘
8P	32	14.2	20.3	600只	8盘	15P	56	26.2	34.3	600只	5盘
						16P	56	26.2	36.3	600只	5盘

纸箱型号	小型	中型	标准型
Carton Type	Small Size	Medium	Standard
高度 Height (CM)	7.5	15	32

REV.	REVISION RECORD	DATE	GENERAL TOLERANCES	SCALE:	NAME	DATE	PART.NO:	DWG.NO:	
AO	NEW RELEASE	21.01.13	LINEAR ANGLES 0.0±0.35 X°REF±6°	1:1	Wang_jr	23.09.15	A2008W0-1XX2XXX	ENDE05	
A1	PART NUMBER RENEWAL	23.09.15							
			UNIT:mm		DESIGNER	Han_Gao	23.09.15	TITLE:	
			SIZE: A4	0.00±0.25	X°±3°	DRAWN	Zijun_Huang	23.09.15	PACKAGE DRAWING
			0.00±0.10	X°X°±2°					REV: A1
									SHEET: 2/2

