

The product using material and processing must conform to the "WI-PZ-001"HSF technical standard control requirements

RoHS+HF

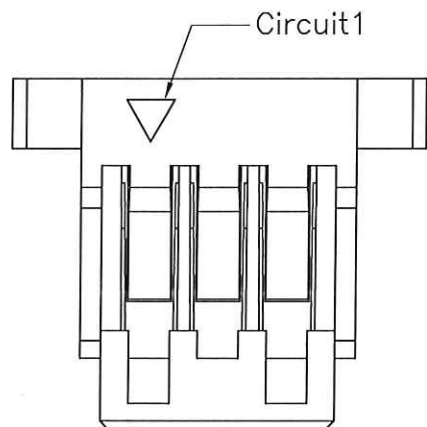
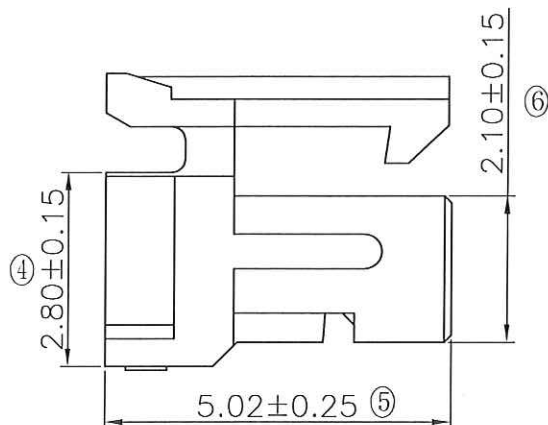
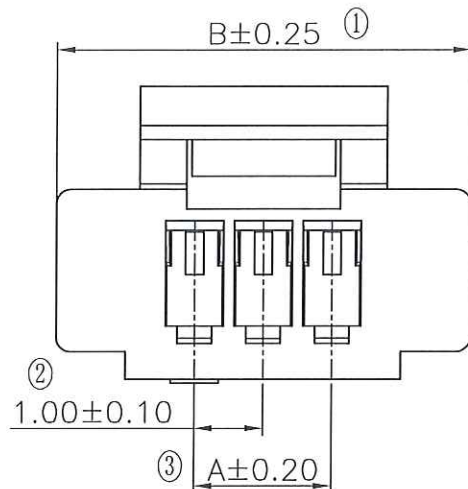

NOTE:

- 1.MATERIAL SPECIFICATION:  
1-1.HOUSING: PA66,UL94V-0
- 2.ELECTRICAL PERFORMANCE:  
2-1.INSULATION RESISTANCE: 100MΩ Min  
2-1.DIELECTRIC WITHSTANDING : 500V
- 3.ENVIRONMENTAL PERFORMANCE:  
3-1.OPERATING TEMPERATURE: -25°C~+85°C.
- 4.PACKAGE SPEC: PE BAG
- 5.P/N:

A1002 H 1 M-1 XX X 0  
 SERIES NO: \_\_\_\_\_  
 CONNECTOR: \_\_\_\_\_  
 TYPE CODE: \_\_\_\_\_  
 MALE FEMALE: \_\_\_\_\_  
 M-MALE  
 COLOR:  
 A-BLACK  
 K-WHITE  
 PIN Q'PY:  
 02~12  
 ROW NO:  
 1-SINGLE ROW

Ordering Information & Dimensions

Circuit	Dimensions(mm)		Circuit	Dimensions(mm)	
	A	B		A	B
02	1.00	5.00	08	7.00	11.00
03	2.00	6.00	09	8.00	12.00
04	3.00	7.00	10	9.00	13.00
05	4.00	8.00	11	10.00	14.00
06	5.00	9.00	12	11.00	15.00
07	6.00	10.00			



REV.	REVISION RECORD	DATE		GENERAL TOLERANCES		SCALE: 1:1	NAME	DATE	PART.NO:	DWG.NO:	 WanLian Technology Co., Ltd
A0	NEW RELEASE			LINEAR	ANGLES	APPROVED	梁科积	2024.5.27	A1002H1M-1XXX0	ENDE05	
				0.0±0.35	X'REF±6'	DESIGNER	梁科积	2024.5.27	TITLE:		
				UNIT:mm	0.00±0.25	X'±3'	DRAWN	梁科积	2024.5.27	Pitch 1.00mm 180°SH 单排带扣胶壳	
			SIZE: A4	0.000±0.10	X'X' ±2'						

The product using material and processing must conform to the "WI-PZ-001"HSF technical standard control requirements

RoHS+HF

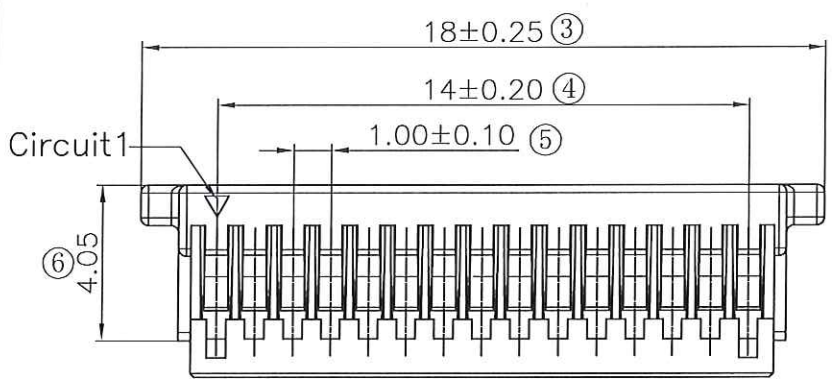
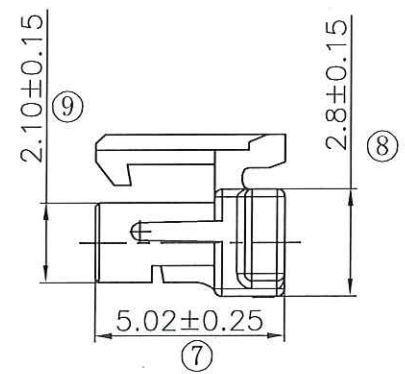
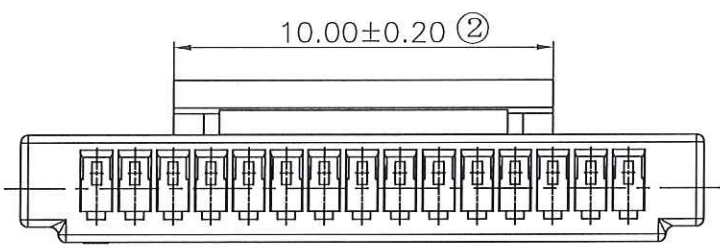
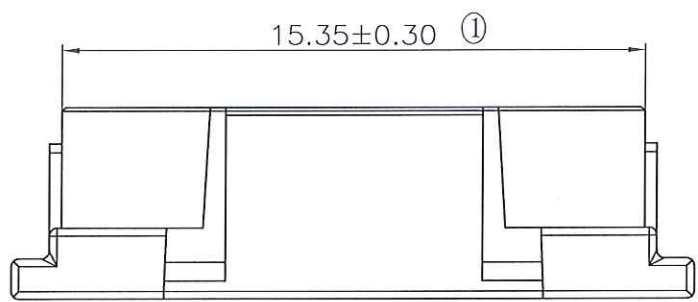

NOTE:  
 1.MATERIAL SPECIFICATION:  
 1-1.HOUSING: PA66,UL94V-0  
 2.ELECTRICAL PERFORMANCE:  
 2-1.INSULATION RESISTANCE: 100MΩ Min  
 2-1.DIELECTRIC WITHSTANDING : 500V  
 3.ENVIRONMENTAL PERFORMANCE:  
 3-1.OPERATING TEMPERATURE: -25°C~+85°C.  
 4.PACKAGE SPEC: PE BAG  
 5.P/N:

A1002 H 1 M-1 XX X 0  
 SERIES NO: \_\_\_\_\_  
 CONNECTOR: \_\_\_\_\_  
 H-HOUSING  
 TYPE CODE: \_\_\_\_\_  
 MALE FEMALE: \_\_\_\_\_  
 M-MALE  
 COLOR:  
 A-BLACK  
 K-WHITE  
 PIN Q' PY:  
 15  
 ROW NO:  
 1-SINGLE ROW



REV.	REVISION RECORD	DATE		GENERAL TOLERANCES		SCALE: 1:1	NAME	DATE	PART.NO:	DWG.NO:	 WanLian Technology Co., Ltd
A0	NEW RELEASE			LINEAR	ANGLES	APPROVED	8/8/24	2024.5.27	A1002H1M-1XXX0	ENDE05	
			UNIT:mm	0.0±0.35	X'REF±6'	DESIGNER	梁林积	2024.5.27	TITLE:		REV: A0
			SIZE: A4	0.00±0.25	X'±3'	DRAWN	肖雨欣	2024.5.27	Pitch 1.00mm 180°SH 单排带扣胶壳 15PIN		
				0.00±0.25	X'±3'						