

10~16P 双卡点
SCALE 0.8:1

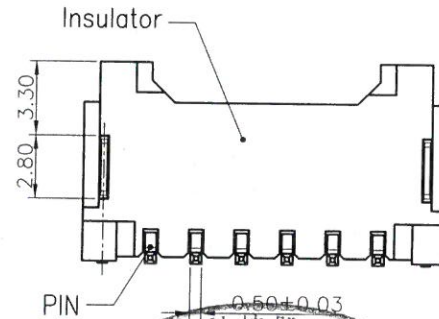
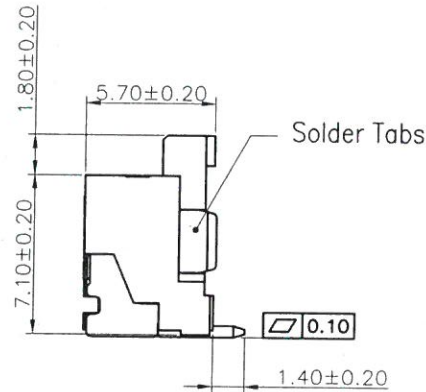
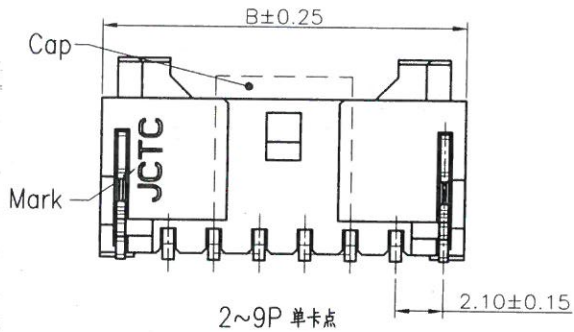
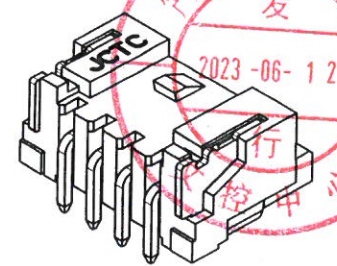
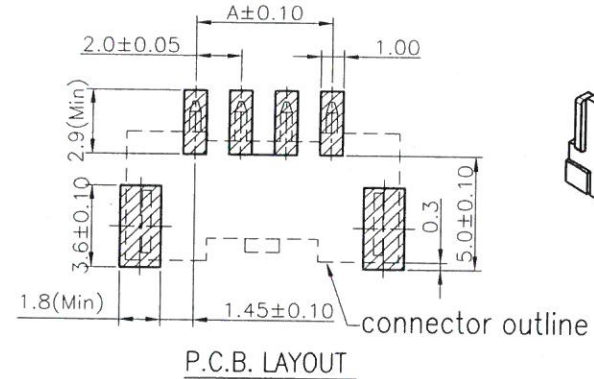
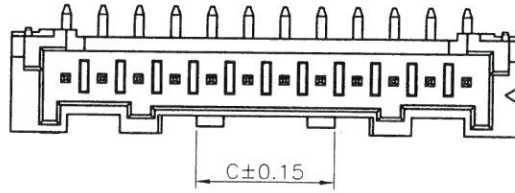
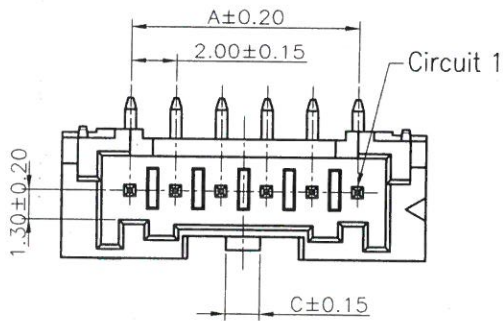

Circuits Part No	Dimensions		
	A	B	C
2P	--	8.00	0.78
3P	4.00	10.00	1.20
4P	6.00	12.00	1.50
5P	8.00	14.00	1.50
6P	10.00	16.00	1.50
7P	12.00	18.00	1.50
8P	14.00	20.00	1.50
9P	16.00	22.00	1.50
10P	18.00	24.00	7.60
11P	20.00	26.00	7.60
12P	22.00	28.00	7.60
13P	24.00	30.00	7.60
14P	26.00	32.00	7.60
15P	28.00	34.00	7.60
16P	30.00	36.00	7.60

Specifications:
 Rated Voltage : 250V AC/DC
 Rated Current : 3A AC,DC
 Withstand Voltage : 800V AC/minute
 Contact Resistance : 10mΩ (MAX.)
 Insulation Resistance : 1000MΩ (MIN.)
 Temperature Range : -25° C~+85° C
 The product using material and processing must conform to the "WI-PZ-142"HSF technical standard control requirements

- 12002 W00 - NP -S A -XX-HF - XX -R
 ① ② ③ ④ ⑤ ⑥ ⑦ ⑧ ⑨
- ① Series No.
 - ② W90 : Side Contact
W00 : Up Contact
 - ③ No. of Circuits
 - ④ S : SMT TYPE
 - ⑤ A : A TYPE
 - ⑥ Blank : Bright-Tin
3E : Matte-Tin
 - ⑦ HF : Halogen Free
 - ⑧ NK : No Mark
 - ⑨ R : Tape & Reel (With Cap)



Part No.	Insulator	Cap	PIN/Solder Tabs
12002W00-NP-SA-HF-R	High temperature plastic, UL94V-0/Natural(Beige)	High temperature plastic, UL94V-0	Brass/Bright Tin-plated
12002W00-NP-SA-HF-NK-R			Brass/Bright Tin-plated
12002W00-NP-SA-3E-HF-NK-R			Brass/Matte Tin-plated
12002W00-NP-SA-5A-HF-NK-R			Brass/Gold Flash
12002W00-NP-SA-5A-HF-R			Brass/Gold Flash

REV.	REVISION RECORD	DATE	GENERAL TOLERANCES	SCALE	NAME	DATE	PART NO.	DWG NO.
A0	新图面发行	18.07.26	LINEAR	1:1			12002W00-NP-SA-XX-HF-XX-R	ENDE05
A1	依PBJOA202212260004新增规格	23.01.09	0.0±0.25	ANGLES				
A2	依ECR20221214464 A3 1处	23.02.28	0.00±0.15	X° REF±6°				
A3	依YB20230223008新增规、换图框	23.03.05	0.00±0.08	X° X'±2°				
					DESIGNER		TITLE	
					DRAWN		PA 2.00mm PITCH 180° SMT WAFER	



1 2 3 4 5 6 7 8

2~4 Contacts

5~16 Contacts

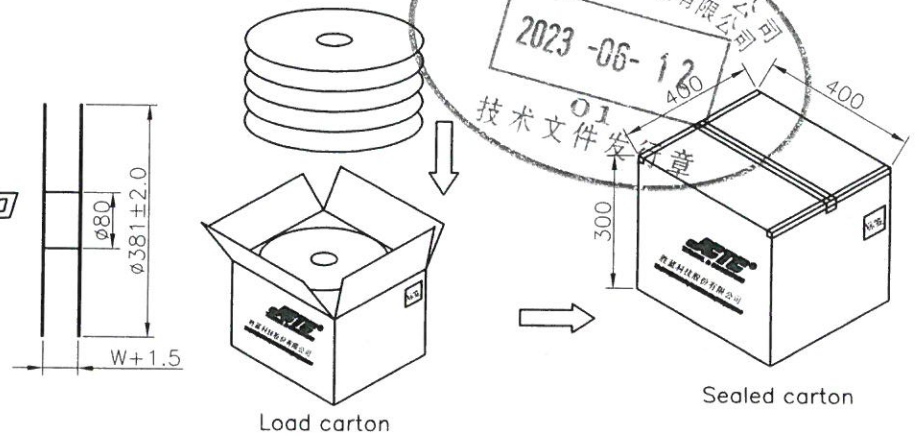
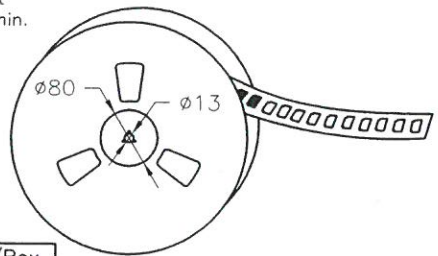
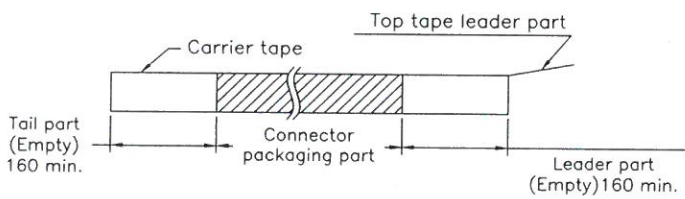
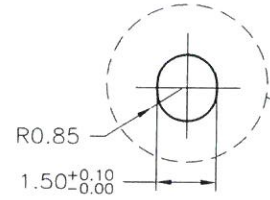
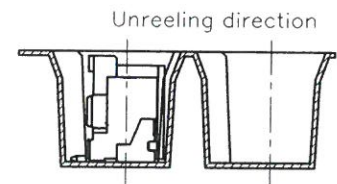
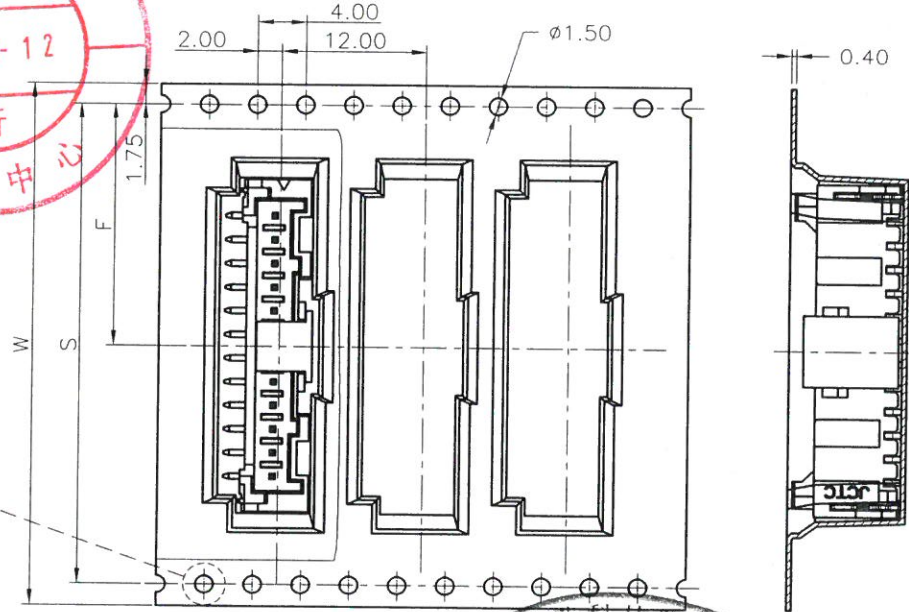
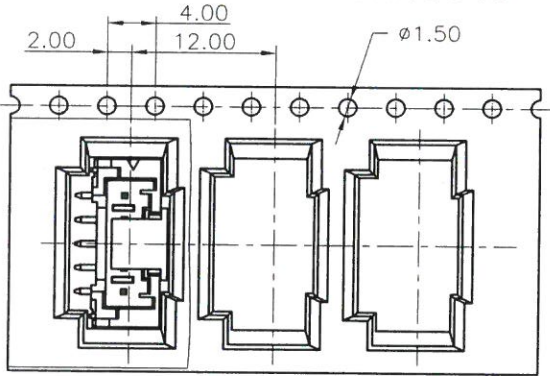

Number of Contacts	W±0.3	F±0.1	S±0.1	Q'ty/Reel	Q'ty/Box
2~4P	24	11.50		750pcs	7500pcs
5~8P	32	14.20	28.40	750pcs	6000pcs
9~13P	44	20.20	40.40	750pcs	4500pcs
14~15P	56	26.20	52.40	750pcs	3750pcs

REV.	REVISION RECORD		DATE	GENERAL TOLERANCES	SCALE 1:1	NAME	DATE	PART NO.	DWG NO.	JCTC ®
	新图面发行									
A1	依PBJOA202212260004新增规格		23.01.09	0.0±0.25	X° REF±6°	DESIGNER	23.03.05	TITLE		
A2	依ECR20221214464 A1处		23.02.28	0.00±0.15	X° ±3°	DRAWN	23.03.05	PA 2.00mm PITCH 180° SMT WAFER		
A3	依YB20230223008新增规、换图框		23.03.05	0.000±0.08	X° X' ±2°					

1 2 3 4 5 6 7 8

REV A3 SHEET 2/2