

Specifications:
 Rated Voltage : 100V AC/DC
 Rated Current : 2A AC,DC
 Withstand Voltage : 800V AC/minute
 Contact Resistance : 10mΩ(MAX.)
 Insulation Resistance : 1000MΩ(MIN.)
 Temperature Range : -25°C~+85°C
 Cap: Thermal Plasticity Resin,UL94V-0
 The product using material and processing must conform to the "WI-PZ-142"HSF technical standard control requirements

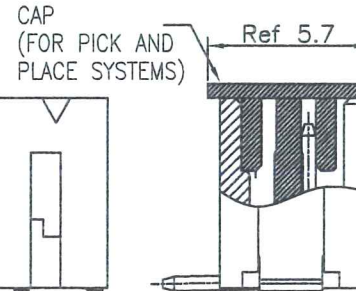

PART NO.	Dimensions	
	A	B
2P	--	8.00
3P	4.00	10.00
4P	6.00	12.00
5P	8.00	14.00
6P	10.00	16.00
7P	12.00	18.00
8P	14.00	20.00
9P	16.00	22.00
10P	18.00	24.00
11P	20.00	26.00
12P	22.00	28.00
13P	24.00	30.00
14P	26.00	32.00
15P	28.00	34.00
16P	30.00	36.00

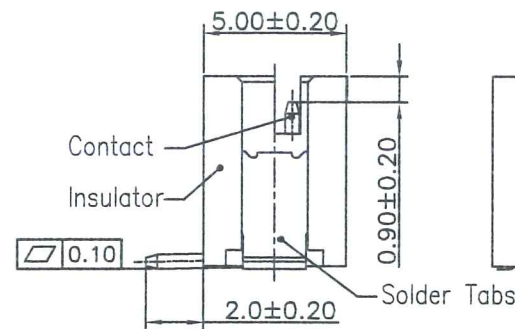
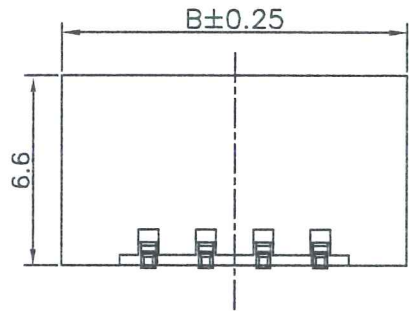
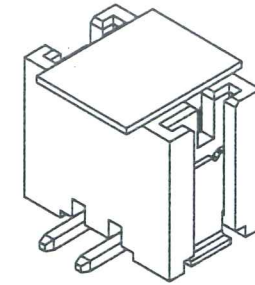
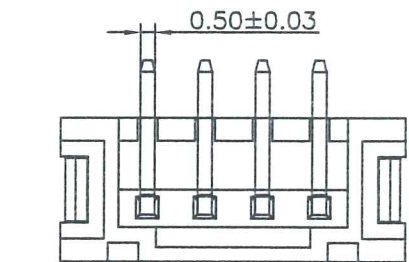

12001W00-2P-S-A-XX-HF-R
 ① ② ③ ④ ⑤ ⑥ ⑦ ⑧

- ① Series No.
- ② W90 : Side Contact
W00 : Up Contact
- ③ No. of Circuits
- ④ S: SMT Type
- ⑤ A: A Type
- ⑥ XX: Finish
- ⑦ HF: Halogen Free
- ⑧ R: Tape & Reel(With Cap)



Part No.	Material	Color	PIN Material	Solder Tabs
12001W00-NP-S-A-R	Nylon 6T,UL94V-0	Natural(Beige)	Brass/Tin-plated	Brass/Tin-plated
12001W00-NP-S-A-5A-R	Nylon 6T,UL94V-0	Natural(Beige)	Brass/Gold flash	Brass/Tin-plated
12001W00-NP-S-A-HF-R	LCP,UL94V-0	Natural(Beige)	Brass/Tin-plated	Brass/Tin-plated
12001W00-NP-S-A-5A-HF-R	LCP,UL94V-0	Natural(Beige)	Brass/Gold flash	Brass/Tin-plated

REV.	REVISION RECORD	DATE	GENERAL TOLERANCES	SCALE	NAME	DATE	PART NO.	DWG NO.	 JCTC [®] TERMINAL&CONNECTORS
C1	更新公司名称	17.10.10	LINEAR	1:1	APPROVED <i>Nelson</i>	22.01.11	12001W00-NP-S-A	ENDE05	
C2	WN2002280023	20.02.28	ANGLES	0.0±0.25 X° REF±6°					
C3	WN2003030026	20.03.03	UNIT: MM	0.00±0.15 X° ±3°	DESIGNER <i>Wu</i>	21.11.11	TITLE	PH 2.00mm PITCH WAFER-SMT TYPE	
C4	新增系列PIN	21.11.12	SIZE: A4	0.000±0.08 X° X' ±2°	DRAWN <i>Wu</i>	21.11.12	大端子		

REV	C4	SHEET	1/2
-----	----	-------	-----

2~5 Contacts

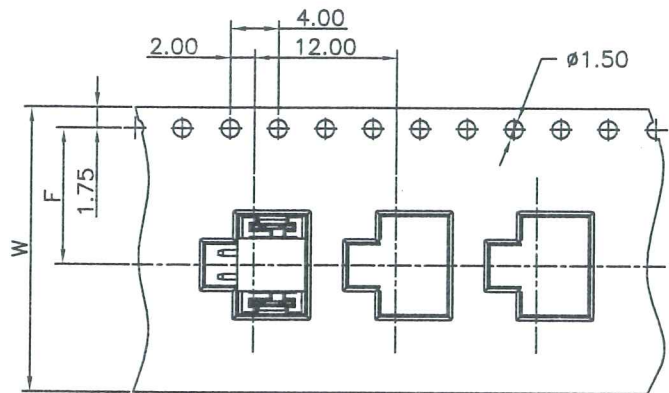

Unreeling direction →

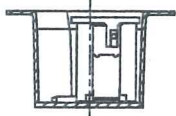

6~16 Contacts

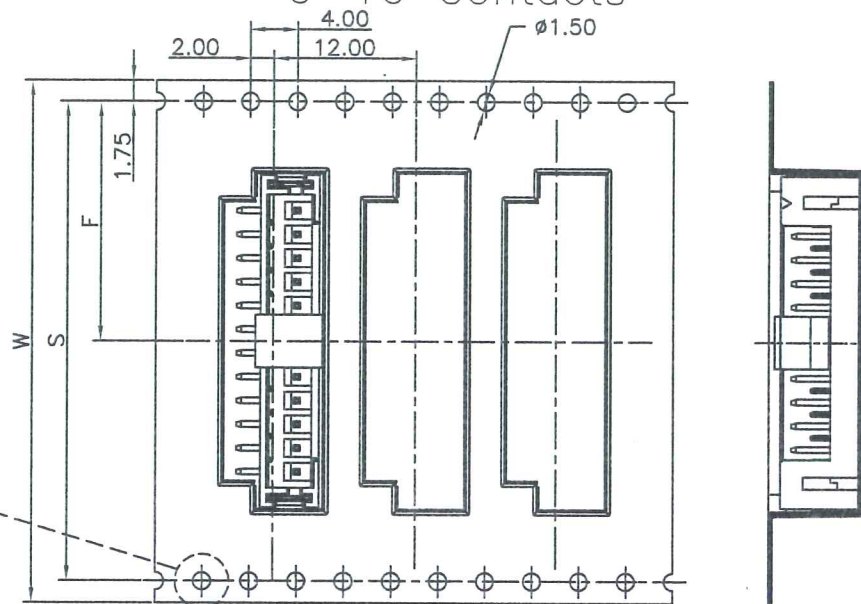

Unreeling direction →

Top tape leader part
Carrier tape

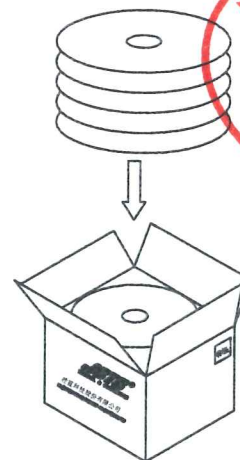
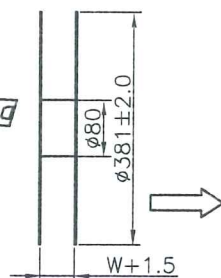
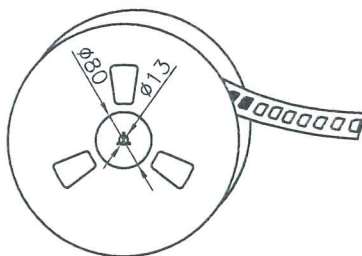

Sealed carton

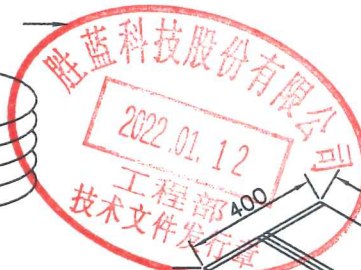

Number of Contacts	W±0.3	F±0.1	S±0.1	Pcs/Reel	Pcs/Box
2P~5P	24	11.50		1,000	10,000
6P~8P	32	14.20	28.40	1,000	8,000
9P~12P	44	20.20	40.40	1,000	6,000
13P~16P	56	26.20	52.40	1,000	5,000

REV.	REVISION RECORD	DATE	GENERAL TOLERANCES	SCALE:	NAME	DATE	PART. NO:	DWG. NO:
C1	更新公司名称	17.10.10	LINEAR	1:1			12001W00-2P-S-A	ENDE05
C2	WN2002280023	20.02.28	0.0±0.25	APPROVED	Jelson	22.01.11		
C3	WN2003030026	20.03.03	X° REF±6°	DESIGNER	WU	22.01.11	TITLE: PH 2.00mm PITCH WAFER-SMT TYPE	
C4	新增系列PIN	21.11.12	X° ±3°	DRAWN	Wu	21.11.12	大盖子	
			UNIT: MM					
			SIZE: A4					
			0.000±0.08					
			X° X'±2°					



REV: C4 SHEET: 2/2